

THE PROPERTY OF THIS DRAWING IS ESTABLISHED BY LAW
IT IS FORBIDDEN TO REPRODUCE IT OR SHOW IT TO THIRD PARTY
WITHOUT A WRITTEN AGREEMENT.

MODIFICATIONS:	VARIED DIMENSIONS AS OF DATE:
7.	10.
8.	11.
9.	12.

MODIFICATIONS:	VARIED DIMENSIONS AS OF DATE:
1.	4.
2.	5.
3.	6.

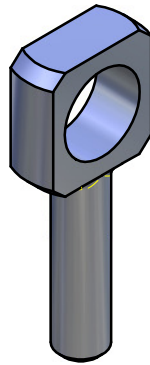
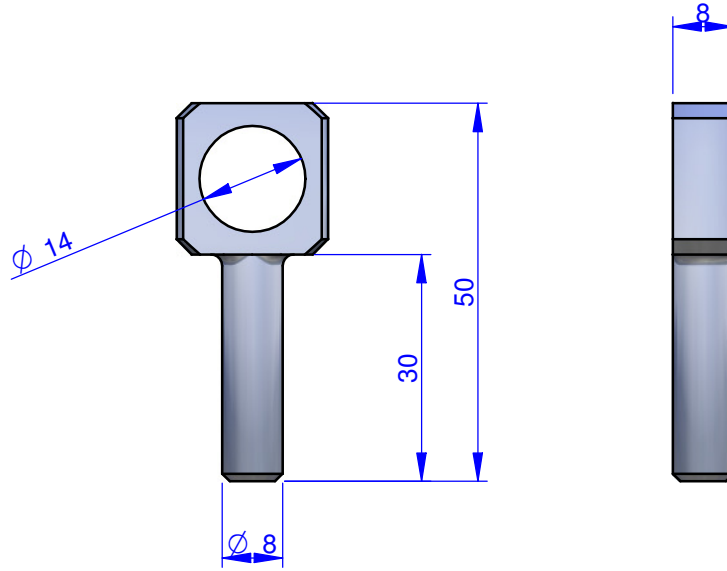

FP Services



DESIGNED FROM
FPSERVICES

DATE 05/2014 WEIGHT 0,009 kg

CODE **CA.05.07.002**

Format A4
UNI 936-76

GENERAL TOLERANCE:
UNI - ISO 2768
CLASSE f

DESCRIPTION

